

## T-AGPV-868/869/878/879 COMPACT AUTO. GUN OPERATION MANUAL

**IMPORTANT:** Read and follow all instructions and SAFETY PRECAUTIONS before using this equipment.

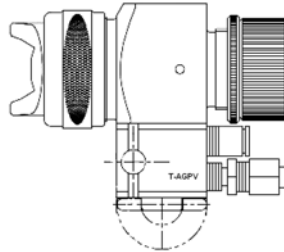

### DESCRIPTION

T-AGPV LVMP guns have been developed to achieve high transfer with high atomization with less air consumption. LVMP stands for Low Volume Medium Pressure. The small, lightweight LVMP compact gun is suitable for installing to robots or automatic machines. Models and application information follows.

### MODELS

Example:

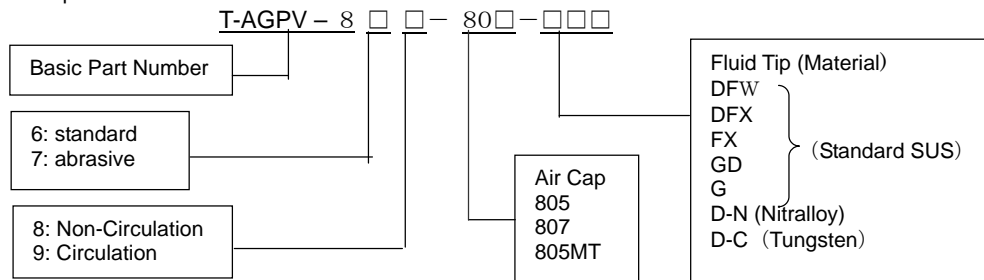

Chart 1.

Marking	Air Cap		Fluid Tip Size (mm)	Pattern Size Shape	Typical Applications
	Code No.	Part Number			
805	802447		DFW (1.6) DFX (1.1) GD (0.7) D (2.2)	220mm (DFX) Taper	Most conventional materials Waterborne & chlorinated solvents D (2.2) is for abrasive materials
	AV-1239-805				
807	802449		DFW (1.5) DFX (1.1) GD (0.7) D (2.2)	300mm (DFX) Straight	Most conventional materials Waterborne & chlorinated solvents D (2.2) is for abrasive materials
	AV-1239-807				
805MT	AV-1239-805MT		FX (1.1) G (0.7)	220mm (FX) Taper	Most conventional materials Waterborne & chlorinated solvents

Chart 2.

Air Cap	Tip Marking (mm)	Part Number (Tip & Needle Lapped Set)	
805, 807	DFW (1.6)	T-AGHV-440-DFW	
	DFX (1.1)	T-AGHV-440-DFX	
	GD (0.7)	T-AGHV-440-GD	
	D (2.2)	T-AGPV-402-D (Nitralloy)	
	D (2.2)	T-AGPV-409-D (Tungsten)	
805MT	FX (1.1) G (0.7)	Fluid Tip	Needle
		AV-651-FX AV-651-G	T-JGA-402-FZ T-JGA-402-G



# SAFETY PRECAUTIONS

This manual contains important information that ALL users should know and understand BEFORE using this equipment. This information relates to USER SAFETY and PREVENTING EQUIPMENT PROBLEMS. To help you recognize this information, we use the following terms to draw your attention to certain equipment labels and portions of this manual. Pay special attention to any label or information that is highlighted by one of these terms:

<b>WARNING</b>	Important information to alert you to a situation that might cause serious injury or loss of life if instructions are not followed.
<b>CAUTION</b>	Important information that tells how to prevent damage to equipment.
<b>NOTE</b>	Information that you should pay special attention to.

## WARNING

The following hazards may occur during the normal use of this equipment. Please read the following chart.

HAZARD	CAUSE	SAFEGUARDS
<p>Fire</p> 	<p>Solvents and coatings can be highly flammable or combustible, especially when sprayed.</p>	<ol style="list-style-type: none"> <li>1. Adequate exhaust must be provided to keep the air free of accumulations of flammable vapors.</li> <li>2. Smoking must never be allowed in spray area.</li> <li>3. Fire extinguishing equipment must be present in the spray area.</li> <li>4. Static discharges must be prevented. Ground (earth) all conductive objects in the spray area, such as a cleaning solvent bucket, fire extinguisher, etc.</li> <li>5. When using solvents for cleaning; <ul style="list-style-type: none"> <li>• Those used for equipment flushing must have a flash point equal to or greater than that of the coating.</li> <li>• Those used for general cleaning must have flash points above 100° F(37.8°C).</li> </ul> </li> </ol>
<p>Inhaling Toxic Substances</p> 	<p>Certain materials may be harmful if inhaled, or if there is contact with the skin.</p>	<ol style="list-style-type: none"> <li>1. Follow the requirements of the Material Safety Data Sheet supplied by coating material manufacturer.</li> <li>2. Adequate exhaust must be provided to keep the air free of accumulations of toxic materials.</li> <li>3. Use a mask or respirator whenever there is a chance of inhaling sprayed materials. The mask must be compatible with the material being sprayed and its concentration. Equipment must be as prescribed by an industrial hygienist or safety expert, and be NIOSH approved.</li> </ol>
<p>Explosion Hazard-Incompatible Materials.</p> 	<p>Halogenated hydrocarbon Solvents- for example: methylene chloride and 1,1,1,-Trichloroethane are not chemically compatible with the aluminum that might be used in many system components. The chemical reaction caused by these solvents reacting with aluminum can become violent and lead to an equipment explosion.</p>	<p>The T-AGB spray gun can be used with these solvents. However, aluminum is widely used in other spray application equipment – such as material pumps, cups, regulators, valves, etc. Check all other equipment items before use of these solvents. Read the label or data sheet for the material you intend to spray. If in doubt as to where or not a coating or cleaning material is compatible, contact your material supplier.</p>
HAZARD	CAUSE	SAFEGUARDS
<p>General Safety</p>	<p>Improper operation or maintenance may create a hazard.</p>	<p>Operators should be given adequate training in the safe use and maintenance of the equipment (in accordance with the requirements of NFPA-33, Chapter 15 in U.S.). Users must comply with all local and national codes of practice and insurance company requirements governing ventilation, fire precautions, operation, maintenance and housekeeping (in the U.S., these are OSHA Sections 1910.94 and 1910.107 and NFPA-33).</p>

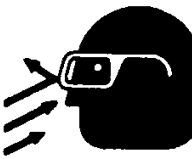
<p>Noise Levels</p> 	<p>The continuous A-weighted sound pressure level of this spray gun may exceed 85dB(A) depending on the air cap/nozzle set-up being used. Sound levels are measured using an impulse sound level meter and analyzer, when the gun is being used in a normal spraying application. Details of actual noise levels produced by the various air cap/nozzle set-ups are available on request.</p>	<p>Wear earplugs when using the spray gun.</p>
<p>Spraying solvent</p> 	<p>Pressured air/fluid passage may be broken when cleaning or flashing with solvent. The solvent may be harmful if contacted with eyes.</p>	<p>Always wear eye protection when spraying or cleaning the equipment.</p>

**MISUES:**

- All spray guns project particles at high velocity and must never be aimed t any part of body.
- Never exceed the recommended safe working pressure for any of the equipment used.
- The fitting of non-recommended or non-original accessories or spare parts may create hazardous conditions.
- Before dismantling the equipment for cleaning or maintenance, all pressures, air and material, must be isolated and released.

Disposal of non-metallic materials must be carried out in an approved manner. Burning may generate toxic fumes. The removal of waste solvents and coating materials should be carried out by an authorized local waste disposal service.

## SPECIFICATION

Max. Air Pressure: 0.9MPa (9.0 bar)  
 Max. Fluid Pressure: 1.4MPa (14.0 bar)  
 Cylinder Air Pressure: Min. 0.34MPa (3.5 bar)  
 Max. 0.49MPa (5.0 bar)  
 Weight: 340g (Gun Body)  
 Mounting Stud: Dia. 19mm x 51mm  
 Fluid Tube: 6x4mm  
 CYL Air Tube: 6x4mm  
 CAP Air Tube: 6x4mm  
 FAN Air Tube: 6x4mm

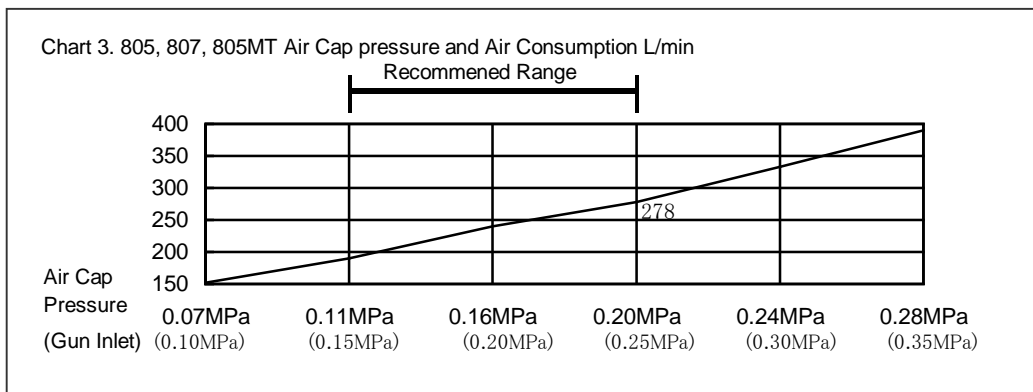



## CAUTION

Do not totally submerge gun in solvent. It is possible to damage the inside of the gun with solids.

## CAUTION

The air cap can be immersed in solvent for cleaning. If orifices are clogged, use a cocktail stick or toothpick to remove obstruction. Never use a steel wire or hard instrument. This will damage air cap and result in a distorted spray pattern.

## REPLACEMENT

### Tools Required

- Crescent Wrench
- 1/2 Box Wrench (for Item No. 3, 21)
- Pliers (for Needle Assy)
- 3, 6, 13, 14mm Open Wrench (for Item No. 12, 17, 28, 15)
- 1.5, 4, 5, 6mm Hex Wrench (for Item No. 16, 26, 29, 25)
- 13mm Box Wrench (for Item No.10, 7)

### Fluid Tip (3)

1. Relieve all air and fluid pressure in system.
2. It is recommended to remove the Gun from the Manifold (22) by removing Bolt (27) before carrying out any maintenance.
3. Remove Adjusting Screw (20) and Needle Spring (18). Pull Needle Assy out from gun body with Pliers.
4. Remove Retaining Ring (1) and Air Cap (2).
5. Remove Fluid Tip (3) with 1/2 Box Wrench.
6. Reassemble in reverse order. Recommended torque of Fluid Tip: 16~20N·m.

## CAUTION

It is recommended that Fluid Tip (3), Needle (12), Needle Seal Kit (7) and Piston Cup (14) be replaced at the same time.

### ☆Replacing Needle (12), Piston Cup (14)

1. Remove Adjusting Screw (20), Lock Nut (19), Needle Spring (18). Pull Needle Assy out from gun body with Pliers.
2. Loosen Set Screw (16) of Retainer (15) by turning 1~2 times with 1.5mm Hex Wrench.
3. Loosen Piston Flange (13) and Retainer (15) a little by turning clockwise with 14mm Spanner for Retainer (15) and 6mm Spanner for Lock Nut (17)
4. Fix this position with Set Screw (16). Remove Retainer (15) with 14mm Spanner and Lock Nut with 6mm Spanner.
5. Using 14mm Spanner for Retainer (15) and 3mm Spanner for Needle (12), remove Needle (12) from Piston Flange (13).
6. Loosen Set Screw (16) with Hex Wrench and remove Piston Flange (13) and Retainer (15), then remove Piston (14).

## CAUTION

Do not try to remove Needle (12) with Lock Nut (17) installed as it may cause the damage.

### ☆Reassembling Needle Assy

1. Apply small amount of liquid gasket on thread of Needle (12) and screw into Piston Flange (13). Then insert Piston Cup (14) and screw into Retainer (15) fully by finger.
2. Using 14mm Spanner on Retainer (15), tighten it approximately 150~180 degree clockwise from the position where maximally screwed in with finger with 3mm Spanner on Needle (12). (when exchanging to new Piston Cup)

## CAUTION

If Piston Cup is not brand-new, tighten at 60~90 degree. (Recommended torque: 0.8~1.0N·m)

3. Tighten Set Screw (16) with 1.5mm Hex Wrench.
4. Using 14mm Spanner on Retainer (15) and then tighten Lock Nut (17) with 6mm Spanner. (Recommended torque: 0.8~1.0N·m)

### ☆Replacing Needle Seal Kit (7)

1. Remove Adjusting Screw (20), Lock Nut (19) and Needle Spring (18). Pull Needle Assy out from Gun Body with Pliers.
2. Remove Needle Seal Kit (7) and Housing (10) with T-AGB-HW-1 Housing Wrench (Optional.)
3. Set Needle Seal Kit (7) and Housing (10) on the shaft of T-AGB-HW-1 and assemble on Gun Body (6).

4. Apply petroleum jelly on Piston Cup (14) of Needle Assy and insert into gun.
5. Insert Needle Spring (18), Lock Nut (19) and assemble Adjusting Screw (20) at the position of 3.5 counter-clockwise turns from fully closed position.
6. Pressure 0.35Mpa (3.5 bar) on CYL and check the movement of needle. If air leaks from 3mm hole on gun body, bind seal tape 1.5 laps on thread of Housing (10).

Figure 5. Gun Exploded View

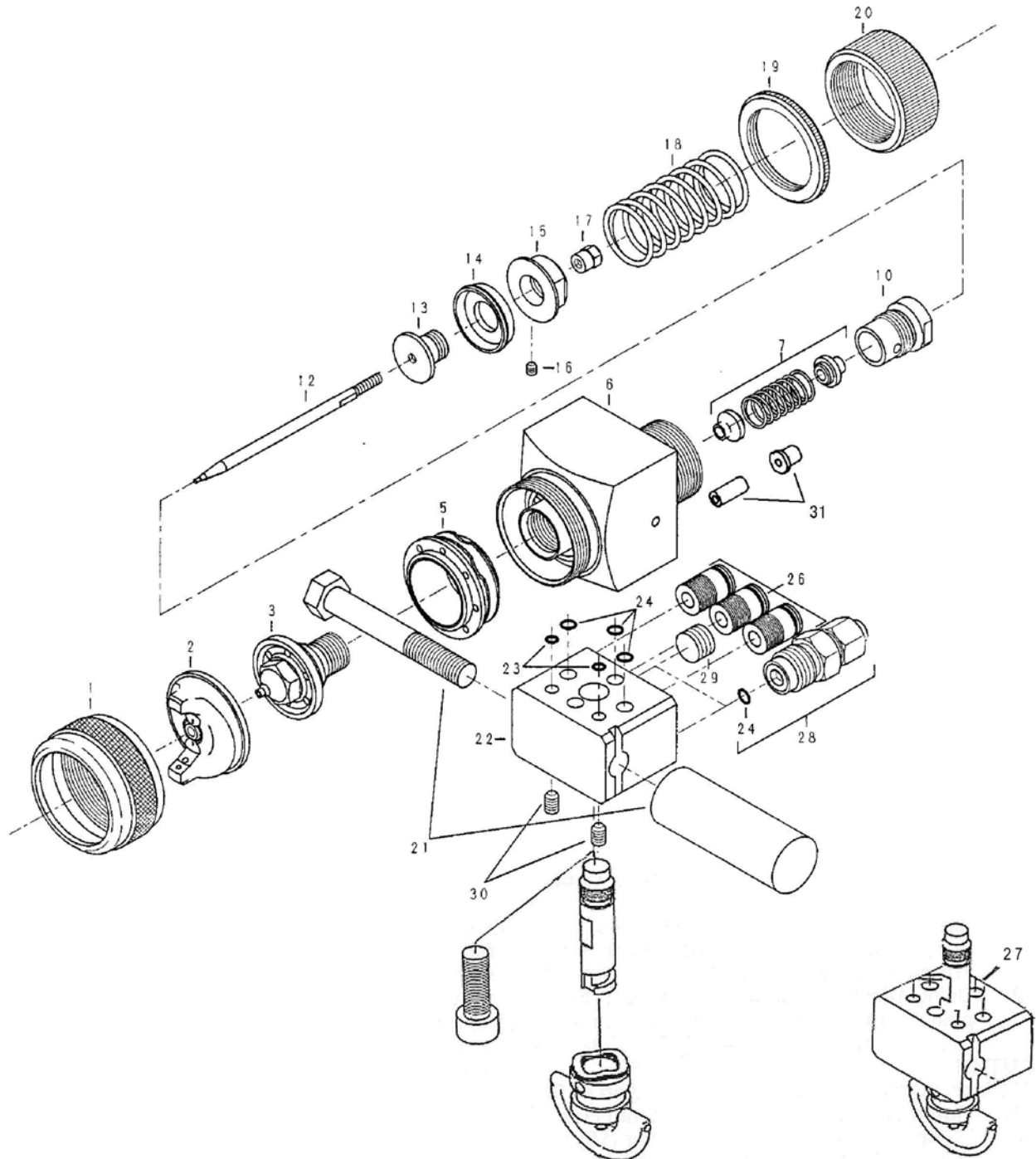



Item No.	Code No.	Part Number	Description	Q'ty	Reference
1	804277	MSG-368	Retaining Ring	1	
2		Refer to Chart 1	Air Cap	1	
*3		Refer to Chart 2	Fluid Tip	1	
*5		T-AGPV-403	Baffle	1	
*6			Gun Body	1	
*7		AGX-7-K2	Needle Seal Kit	1	(4 seals, 2 springs)
*10		T-AGPV-13	Housing	1	
*12		Refer to Chart 2	Needle	1	
*13	805470	T-AGB-101	Piston Flange	1	
*14	805472	T-AGB-102	Piston Cup	1	
*15	805473	T-AGB-103	Retainer	1	
*16	805475	T-AGB-104-K5	Set Screw Kit of 5	1	
*17	805477	T-AGB-105	Lock Nut	1	
*18	805479	T-AGB-106	Needle Spring	1	
*19		T-AGPV-117	Lock Nut	1	
*20		T-AGPV-118	Adjusting Screw	1	
21		AGX-3-K	Mounting Stud Kit	1	
22			Manifold	1	
23		T-AGPV-140-K2	O-Ring Kit of 2	2	
24		T-AGPV-131-K5	O-Ring Kit of 5	3	
26		EC-6-R1/8A-M-R1001	Air Connector	3	
27		T-AGPV-310	Bracket handle shaft ass'y	1	(include o-ring)
28		EF7014-1	Connector Kit for Fluid w/O-Ring	1	2 for circulating
29			Plug 1/8	1	None for circulating
30			Set Screw M5xL8	2	
31	804103	KK-5017	Fluid Seal Kit for abrasives	1	(3 seals, 1 collar)
*marked parts are included in the following Gun Body Package.					
		T-AGPV-880-xxx	Gun Body Package (non-circulating)		
		(available with G, GD, FX, DFX, DFW)			
		T-AGPV-890-xxx	Gun Body Package (circulating)		
		(available with G, GD, FX, DFX, DFW)			

## SERVICE CHECK



### Normal Spray Pattern

The proper combination of fluid pressure, fan and atomization air pressure, and fluid tip size should result in a pattern of this shape.

PROBLEM	CAUSE	CORRECTION
Will not spray.	No pressure to gun. Piston stops moving.	Check air and material lines. Check CYL air pressure.
Improper spray pattern. 	A. Gun not adjusted properly. A, B Material build up on the air cap (2) or fluid tip (3).  <b>Note</b> To determine where the material build up is, rotate the air cap 180° and test spray. If the pattern stays in the same position, the condition is caused by material build up on the fluid tip. If the pattern changes with air cap movement, the build up is in the air cap. C, D. Wrong material or material too thick. Insufficient material or atomizing air pressure too high.	A. Re-adjust. See "Operation Section". A, B Clean the air cap or fluid tip. See "Preventive Maintenance".  C, D Adjust material pressure or thin material. Increase material or reduce atomizing air pressure.
Jerky or fluttering spray. 	1. Insufficient material in the tank or an obstruction in the line. 2. Gun material passage plugged. 3. Worn Needle Seal Kit (7). 4. Loose or damaged Fluid Tip (3).	1. Fill tank or clear obstruction. 2. Clean. 3. Replace. 4. Tighten or replace.
Air leaking from Adjusting Screw (20).	1. Damaged or worn Piston Cup (14). 2. Damaged cylinder of Gun Body (6).	1. Replace. 2. Replace.
Dripping from Fluid Tip.	1. Worn or damaged Fluid Tip (2) or Needle (12). 2. Needle Spring (18) damaged or 3. deformed.	1. Replace. 2. Replace.
Air or fluid leaking from Gun Body (6).	Damaged or worn Needle Seal Kit (7)	Replace.

## ACCESSORIES

Code No.	Part Number	Description
805153	SSL-10	Gun Lube
806472	42884-214-K5	Cleaning Brush Kit of 5
800163	GC-100-K48	Gun Cover Kit of 48
800196	HD-505	Quick Cleaner
800279	QMGZ-5200	Solvent Saver (10L)
	KK-5033-805	Air Cap Test Gauge (for AV-1239-805)
	KK-5033-807	Air Cap Test Gauge (for AV-1239-807)
	KK-5033-805MT	Air Cap Test Gauge (for AV-1239-805MT)

The figures and specifications of these products are subject to change without any notice.  
※Delrin and Teflon are both registered marks of E.I.Du Pont de Nemours and Company.

## DEVILBISS DIVISION

### RANSBURG INDUSTRIAL FINISHING KK

15-5, Fuku-ura 1Chome, Kanazawa-ku, Yokohama, Japan 〒236-0004  
TEL.81-45-785-6371 FAX.81-45-785-6517

For more information, please contact:

